



ITAB

TUOTEKUVASTO

ITAB Finland

Sisällys

KALUSTEJÄRJESTELMÄT

Perusjärjestelmä, korkea jalka H19.....	5
Perusjärjestelmä, matala jalka H13.....	7
Taustajärjestelmät.....	11
Päättykehys.....	14
Perusjärjestelmä, SIK-kulma	16
Kulmahyllyt.....	19
Pilarikaluste.....	20
Säätölista.....	21
Heavy.....	22
Gondola.....	25

VARUSTELUOSAT

Teräshylly.....	30
Lankahylly.....	31
Kannattimet.....	32
Reunat ja jakajat.....	33
Puuhylly.....	35
Puuhylly kannatinlistoihin.....	36
Lasihylly.....	37
Lasihylly kehyksellä.....	38
Muut hyllyt.....	39
Laarikorit.....	41
Hintalistat.....	42
Hintalistan kannatin.....	43
Infoprofiili.....	45
Tuoteinfot.....	46
Rekki.....	47
Lattarekki.....	49
Raskaan tavaran rekki.....	50
Säätörekki.....	51
Paneelin varusteluosat.....	53
Reikätaustan varusteluosat.....	55
Varusteluosat säätöputkeen.....	57
Värit ja materiaalit.....	58

ITAB Finland

ITAB myy, suunnittelee, valmistaa ja asentaa täyden palvelun myymäläkalustekonsepteja.

Me autamme asiakkaitamme muuttamaan brändikokemuksen todellisuudeksi. Luomme asiakkaillemme mitattavissa olevien tulosten avulla paremman asiakaskokemuksen, myynnin, tehokkuuden, palvelun sekä käyttökustannukset.

Löydät tästä **kuvastosta peruskalustejärjestelmämme vakiotuotteita.**

Jos haluat myymäläsi tai brändisi asiakaskokemuksen uudelle tasolle ja tarvitset räätälöityjä toteutuksia, ole yhteydessä ITAB Finlandin asiakaspalveluun tai myyjääsi ja luodaan yhdessä unohtumaton kokemus asiakkaallesi.



ITAB Finland oy

Puh: 0207 121 611

asiakaspalvelu@itab.com

www.itab.fi

Referenssejämme:



Kalustejärjestelmät

Perusjärjestelmä, korkea jalka H19

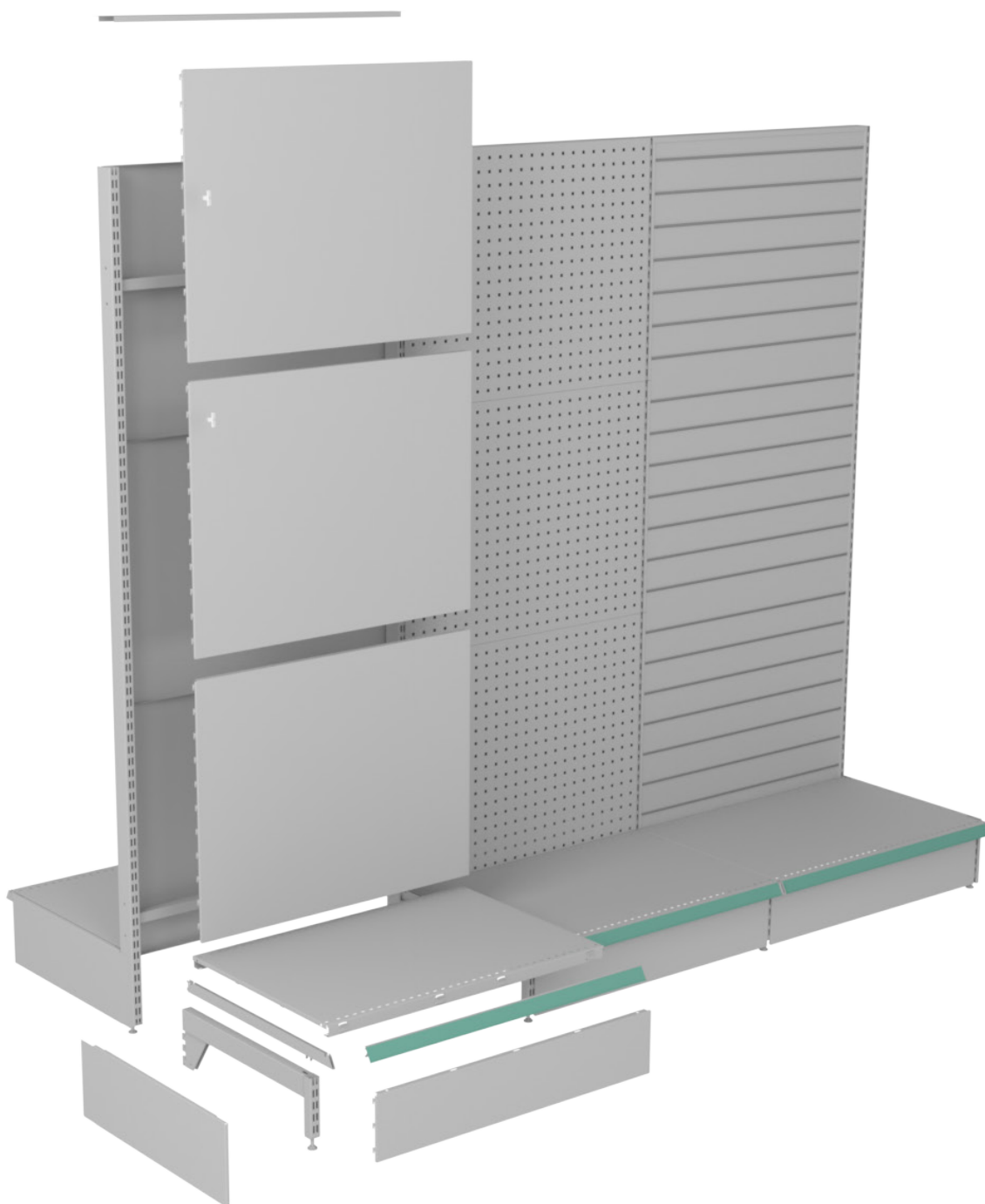

Perusjärjestelmä, korkea jalka H19

L=Leveys/cm

D=Syvyys/cm

H=Korkeus/cm

Ø mm



Säätöputki + tallat 60x30x2,5 mm

501017	H139
501019	H162
501021	H187
501045	H200
501023	H210
501025	H232
501031	H302

Säätöputki + tallat 80x30x2,5 mm

1016429	H139
1006440	H162
550218	H187
501316	H200
550220	H210
550222	H232
1006354	H302



Välituki ruuvikiinnityksellä

1015068	L60
1014910	L90
1015069	L120

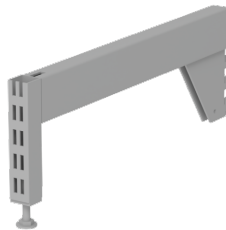

Jalka 2,5 mm seinämän säätöputkelle

502000	H19	D40
502001	H19	D50
502002	H19	D60
502003	H19	D80



Jatkojalka

1018249	H19	D10
1022847	H19	D20
2008600	H19	D30

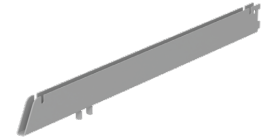

Alatason kannatin

502004	H3	D40
502005	H3	D50
502006	H3	D60
502007	H3	D80

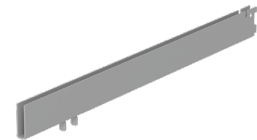

Alatason kannatin, suorapäinen

502022	H3	D40
502023	H3	D50
502024	H3	D60
502025	H3	D80

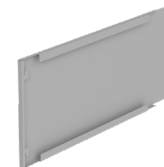

Päätysokkeli

502085	H21	D40
502086	H21	D50
502087	H21	D60
502088	H21	D80

Perusjärjestelmä, matala jalka H13

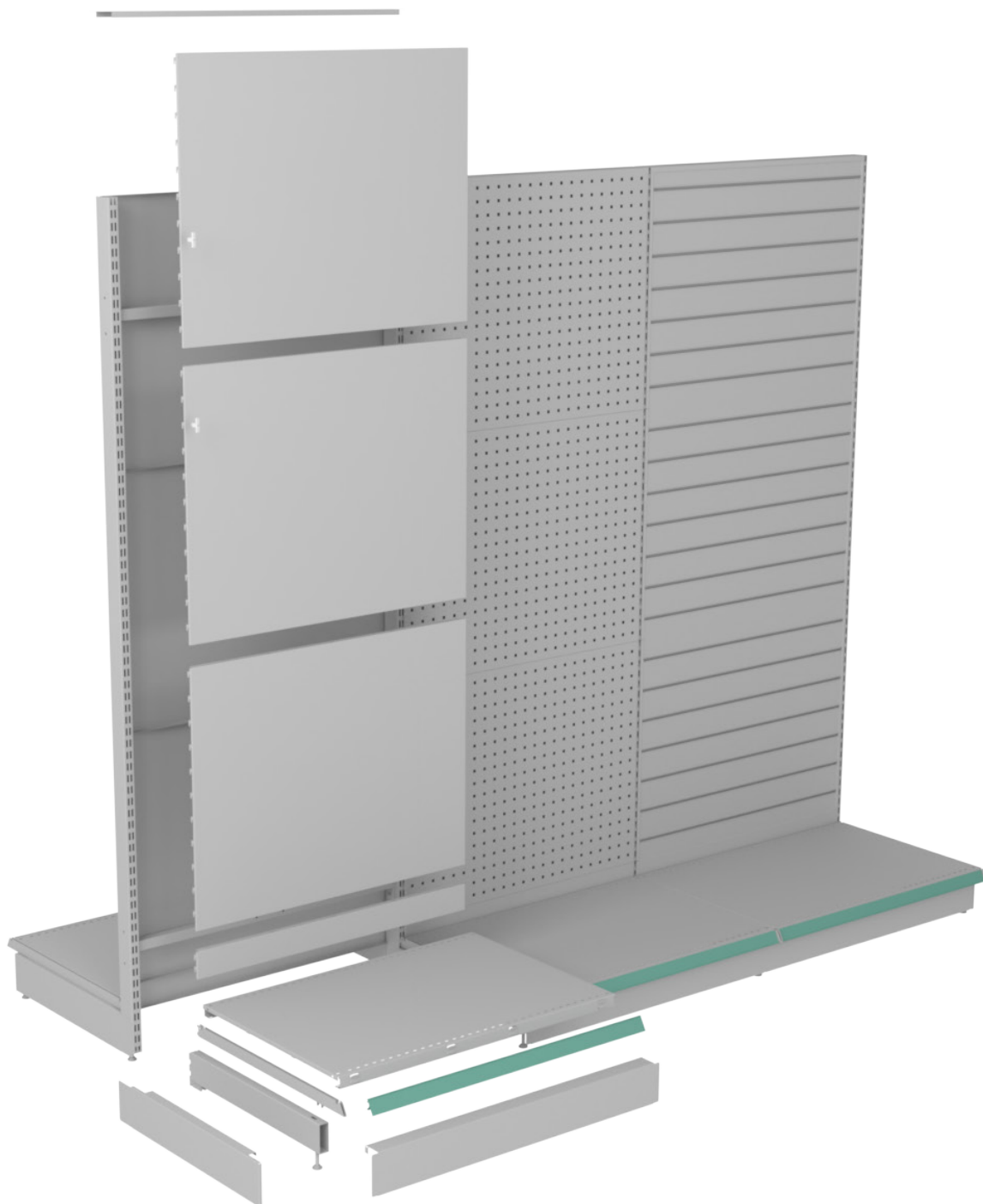

Perusjärjestelmä, matala jalka H13

L=Leveys/cm

D=Syvyys/cm

H=Korkeus/cm

Ø mm



Säätöputki + talle 60x30x2,5 mm matalaan jalkaan

521251	H139
521252	H162
521253	H187
521254	H200
521255	H210
521256	H232
521259	H302

Säätöputki + talle 80x30x2,5 mm matalaan jalkaan

1018833	H139
1017105	H162
521260	H187
521261	H200
521262	H210
521263	H232
1100163	H302



Välituki ruuvikiinnityksellä

1015068	L60
1014910	L90
1015069	L120



Matala jalka 2,5 mm seinämän säätöputkelle

521240	H13	D40
521241	H13	D50
521242	H13	D60



Jatkojalka matala

1019825	H13	D10
1006103	H13	D20
1107509	H13	D30

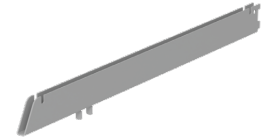

Alatason kannatin

502004	H3	D40
502005	H3	D50
502006	H3	D60
502007	H3	D80



Alatason kannatin, suorapäinen

502022	H3	D40
502023	H3	D50
502024	H3	D60
502025	H3	D80

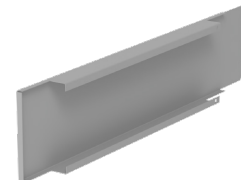

Päätösokkeli matalaan jalkaan

521248	H10	D40
521249	H10	D50
521250	H10	D60

L=Leveys/cm

D=Syvyys/cm

H=Korkeus/cm

Ø mm



Sokkeli matalaan jalkaan

521245	L60	H10
521246	L90	H10
521247	L120	H10

L=Leveys/cm

D=Syvyys/cm

H=Korkeus/cm

Ø mm

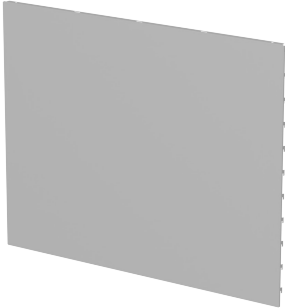

Terästausta

501063	L60	H38
501104	L60	H48
501105	L60	H70
501073	L90	H38
501106	L90	H48
501107	L90	H70
501093	L120	H38
501108	L120	H48
501109	L120	H70

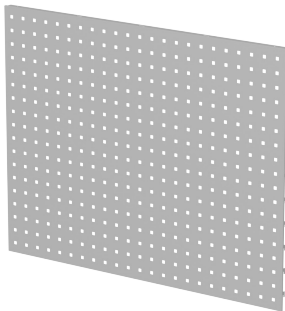

Reikätausta

501111	L60	H38
501112	L60	H48
501113	L60	H70
501700	L90	H38
501114	L90	H48
501115	L90	H70
501701	L120	H38
501116	L120	H48
501117	L120	H70

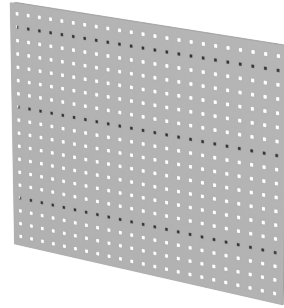

Reikätausta vahvistettu

1024520	L90	H38
1024638	L90	H48
1024458	L90	H70



Alatäyte H8

520196	L60	H8
520197	L90	H8
520198	L120	H8



Sokkeli / Alatäyte H18

501100	L60	H18
501101	L90	H18
501102	L120	H18

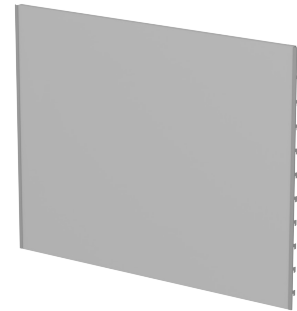

Puutausta koukkulistoilla

510100	L60	H70
510103	L60	H96
510106	L60	H118
510109	L60	H141
510101	L90	H70
510104	L90	H96
510107	L90	H118
510110	L90	H141
510102	L120	H70
510105	L120	H96
510108	L120	H118
510111	L120	H141

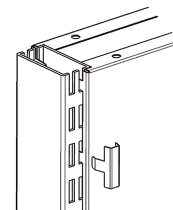

Taustan lukitusnasta, sinkitty

501120	H3
--------	----

Taustajärjestelmät

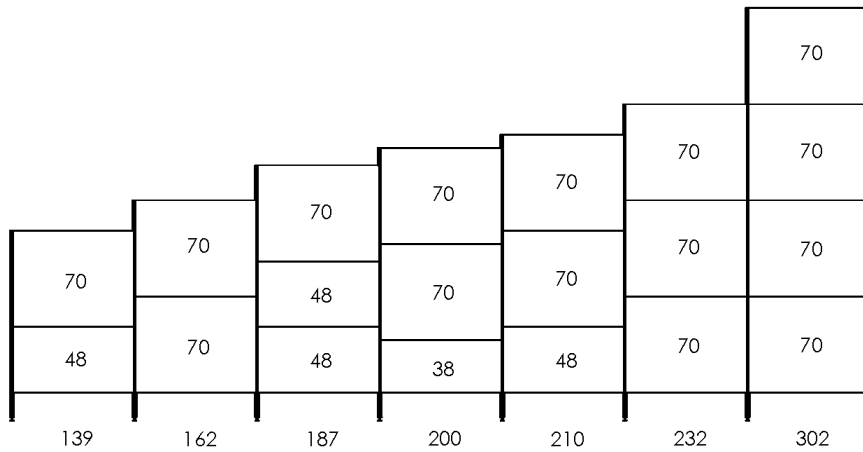

Perusjärjestelmä, jalka H19

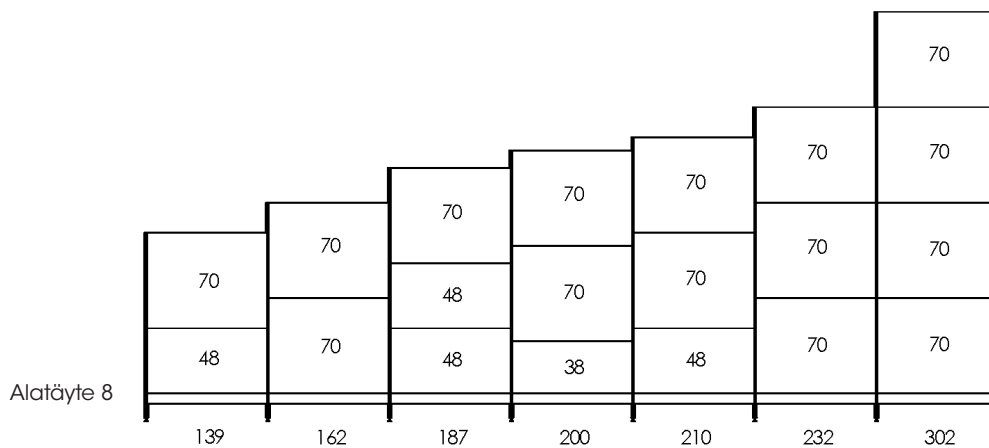

Perusjärjestelmä, jalka H13

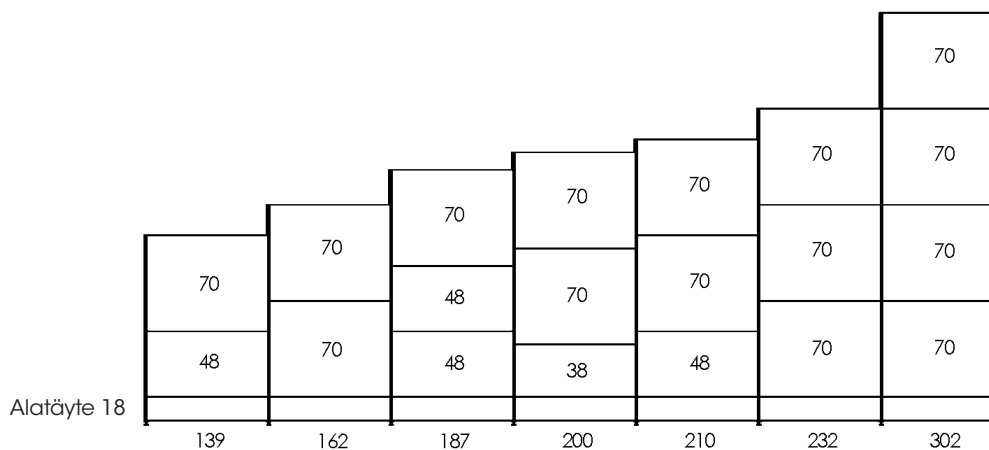

Perusjärjestelmä, ilman jalkaa

L=Leveys/cm

D=Syvyys/cm

H=Korkeus/cm

Ø mm



Peitekouru 30x60

520389	L60	D7,5
520390	L90	D7,5
520391	L120	D7,5

Peitekouru 30x80

1011077	L60	D9,5
1006441	L90	D9,5
1011074	L120	D9,5

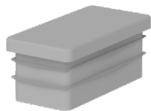

Sisätulppa

800476	L3	D6	valkoinen
905946	L3	D6	harmaa
905942	L3	D6	musta

800382	L3	D8	valkoinen
905947	L3	D8	harmaa
906832	L3	D8	musta



Taustan pidike, RST

557618

Taustan max. vahvuus 6 mm

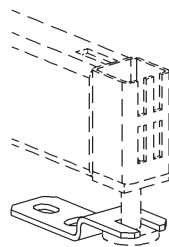

Lattiakiinnitin, sinkitty

501507



Säädettävä seinätuki sisältää ruuvit

521295 D37...70



Seinätuki, ruuvattava

572298 D0...15
521292 D15...55



Jatkosäätöputki 60x30x2,5 mm

1007213	H19
1005990	H38
1005358	H48
1009636	H58
1007954	H70

Jatkosäätöputki 80x30x2,5 mm

1005500	H19
1005357	H38
1007363	H48
1104750	H58
1003766	H70

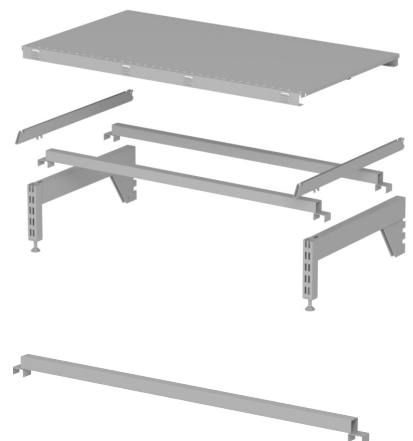

Alatason tuki

550320 L90

Tukia tarvitaan 2 kpl / alataso.

L=Leveys/cm

D=Syvyys/cm

H=Korkeus/cm

Ø mm

**Kulmakiinnike säätöputkiin
sinkityillä ruuveilla**

2028135 L5 H12

**Kulmakiinnike säätöputkiin
mustilla ruuveilla**

2028256 L5 H12

Päätykehys

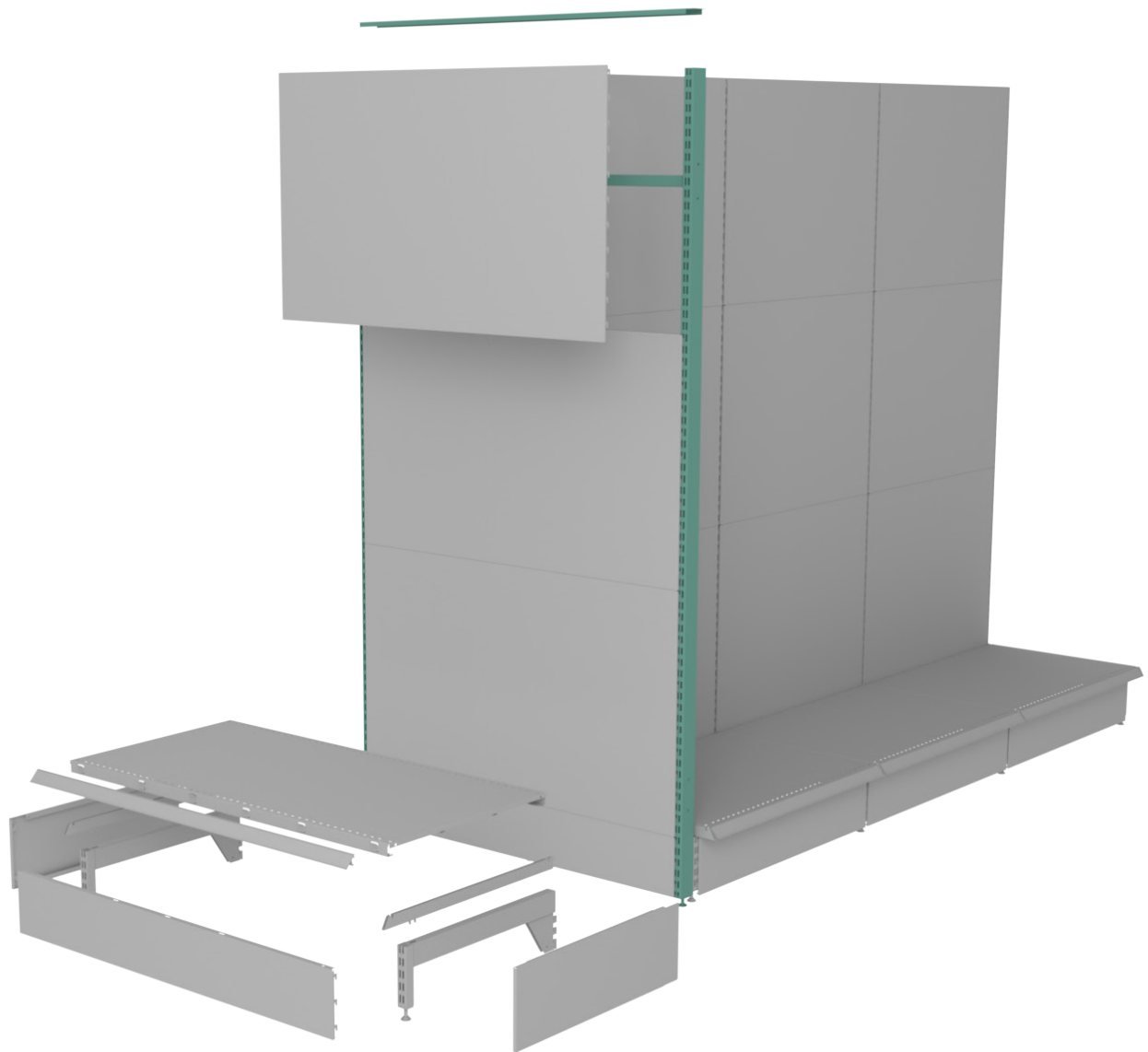

Päätykehys

L=Leveys/cm

D=Syvyys/cm

H=Korkeus/cm

Ø mm



Säätöputki + tallat 60x30x2,5 mm

501017	H139
501019	H162
501021	H187
501045	H200
501023	H210
501025	H232
501031	H302

Säätöputki + tallat 80x30x2,5 mm

1016429	H139
1006440	H162
550218	H187
501316	H200
550220	H210
550222	H232
1006354	H302

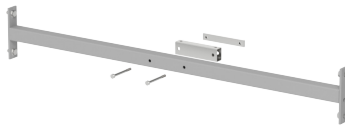

Päätykehysten välituki, sisältää ruuvit

1015066	L60
1014909	L90
1015067	L120



Peitekouru 30x60

520389	L60	D7,5
520390	L90	D7,5
520391	L120	D7,5

Perusjärjestelmä, SIK-kulma

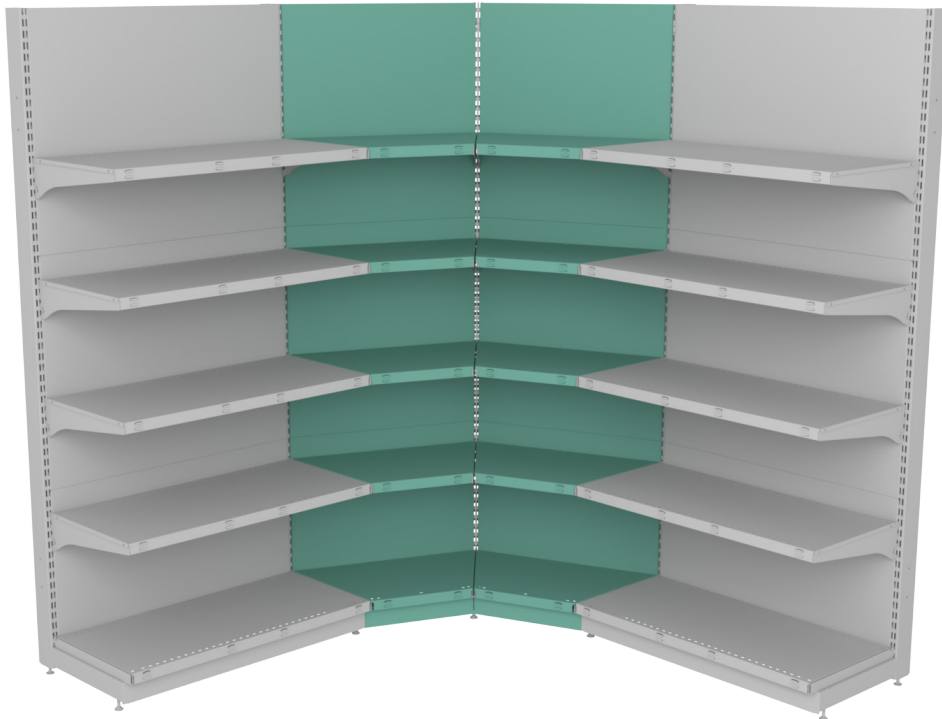

SIK-kulma mitoitus

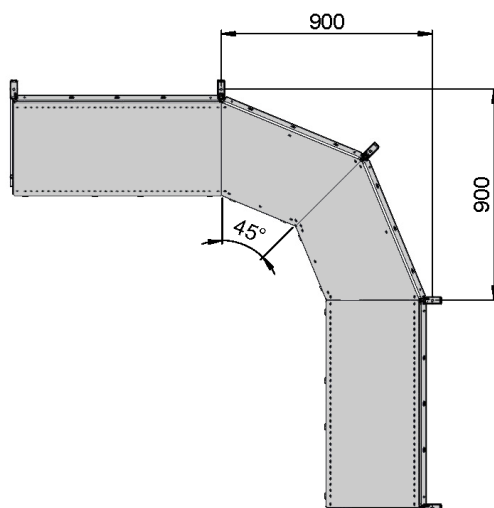

Perusjärjestelmä, SIK-kulma

L=Leveys/cm

D=Syvyys/cm

H=Korkeus/cm

Ø mm

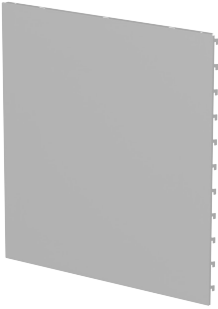

SIK-terästausta 45°

501279	L65	H38
501121	L65	H48
501122	L65	H70

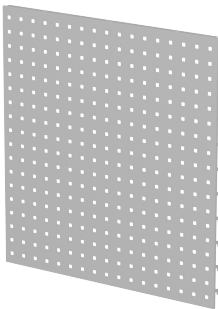

SIK-reikätausta 45°

501287	L65	H38
501123	L65	H48
501124	L65	H70



SIK-alatäyte 45°

501515	L65	H18
--------	-----	-----



SIK-sokkeli 45°

502016	H18	D40
502017	H18	D50
502018	H18	D60

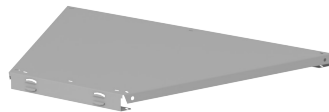

SIK-teräshylly, sisäkulma 45°

501174	D30	H3
501175	D40	H3
501176	D50	H3
501177	D60	H3

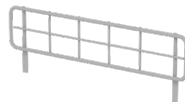

SIK-ritiläetureuna 45°, sinkitty

501237	L42	D30	H8
501236	L34	D40	H8
501235	L26	D50	H8
501234	L19	D60	H8

D=SIK-hyllyn syvyys

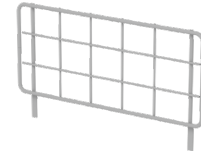

SIK-ritiläetureuna, korkea 45°, sinkitty

501243	L26	D50	H15
501242	L19	D60	H15

D=SIK-hyllyn syvyys

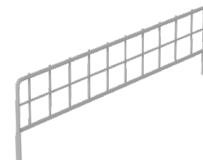

SIK-ritiläjakaja 45°, sinkitty

501269	D40	H8	D1 34
501271	D60	H8	D1 51

D=SIK-hyllyn syvyys

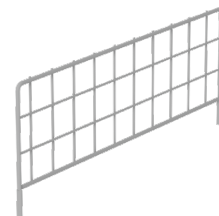

SIK-ritiläjakaja 45° korkea, sinkitty

501275	D60	H15	D1 51
--------	-----	-----	-------

D=SIK-hyllyn syvyys

L=Leveys/cm

D=Syvyys/cm

H=Korkeus/cm

Ø mm



SIK-lasireuna ja kulmapidikkeet teräshyllyyn 45°

501216	L37	D30	H10
501215	L29	D40	H10
501214	L21	D50	H10
501213	L14	D60	H10

D=SIK-hyllyn syvyys



Lasijakajan kulmapidike teräshyllyyn, muovi

501415	H5
501209	H8
501208	H10



Lasijakajan pidike teräshyllyyn, muovi

501248	H5
501249	H8
501207	H10



SIK-hyllyn hintalista 45°, muovi

Valkoinen

501200	L34	D40	H4	39
501201	L26	D50	H4	39
501202	L19	D60	H4	39

Harmaa RAL 9007

1023528	L26	D50	H4	39
1022647	L19	D60	H4	39

Valkoinen

1103942	L34	D40	H5	52
1103877	L26	D50	H5	52

Harmaa RAL 9007

1006641	L42	D30	H5	52
1006640	L34	D40	H5	52
1006639	L26	D50	H5	52
1105977	L19	D60	H5	52

Musta

1108084	L34	D40	H5	52
1107002	L26	D50	H5	52
1107577	L19	D60	H5	52

Kulmahyllyt

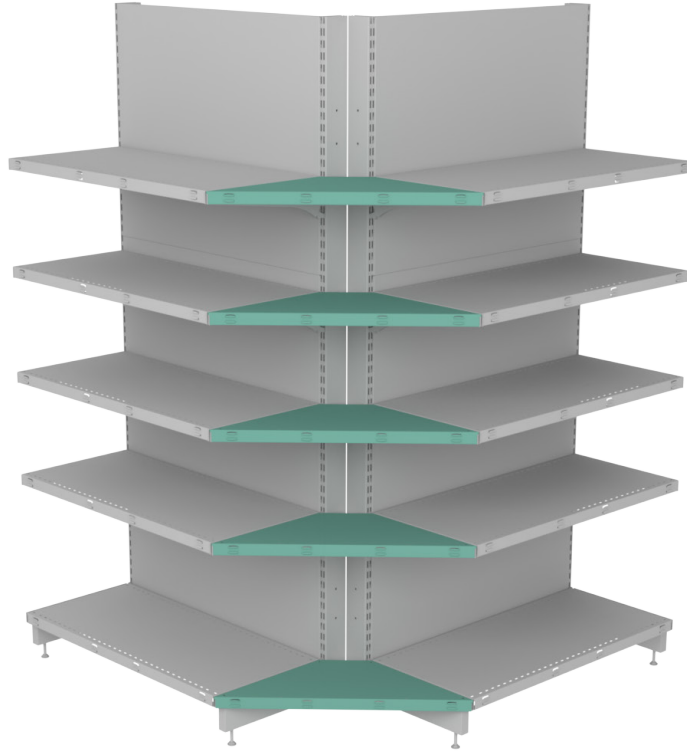

L=Leveys/cm

D=Syvyys/cm

H=Korkeus/cm

Ø mm



Kulmahylly 30x30 putkiin

2006293 D20 H3



Kulmahylly 30x60 putkiin

2006834 D20 H3
 1100338 D30 H3
 1023544 D40 H3
 1025241 D50 H3
 2024596 D60 H3

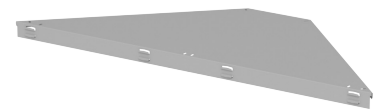

Kulmahylly 30x80 putkiin

2009762 D30 H3
 2009763 D40 H3
 2009764 D50 H3
 2009765 D60 H3

Pilarikaluste

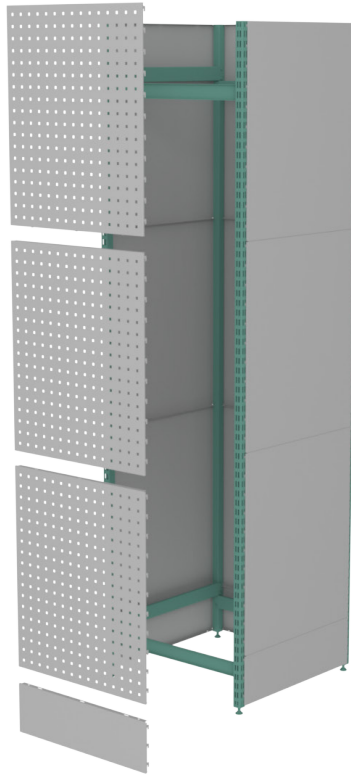

L=Leveys/cm

D=Syvyys/cm

H=Korkeus/cm

Ø mm



Kulmasäätöputki 30x30x2 mm

1007898	H210
501917	H232
501920	H302



**Välituki kulmasäätöputkeen,
sisältää poraruuvit**

501925	L60
501926	L90

Säätölista

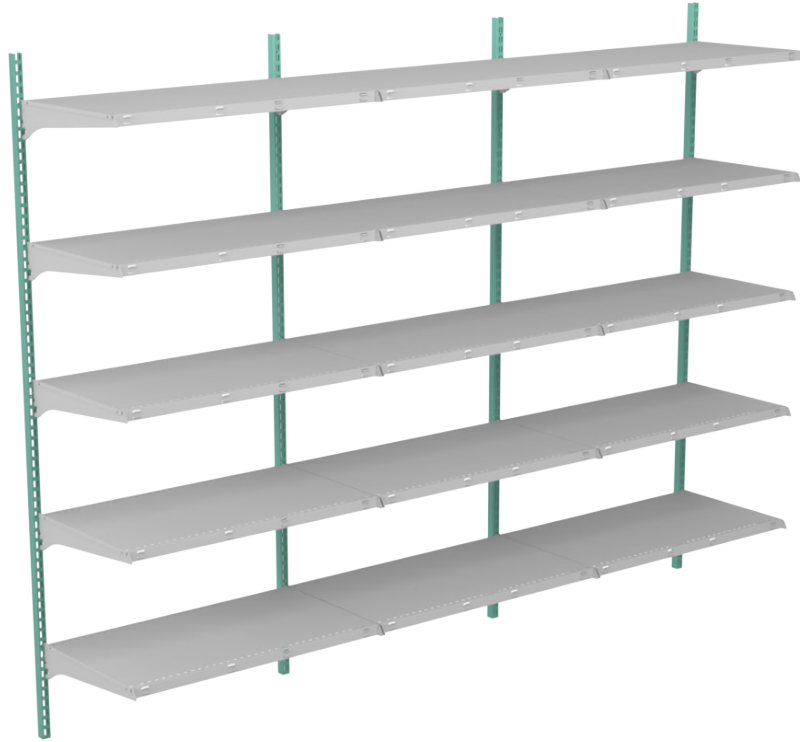

HUOM! Kevyelle kuormalle, kiinnityksessä huomioitava seinän materiaali

L=Leveys/cm

D=Syvyys/cm

H=Korkeus/cm

Ø mm



Säätölista, ruuvikiinnitteinen

521300 H141

521301 H211

521302 H259

Kiinnitetään suoraan seinään

Heavy



Heavy

L=Leveys/cm

D=Syvyys/cm

H=Korkeus/cm

Ø mm



Etuputki Heavy 30x30

1011501	H139
1011500	H162
1011499	H187
1011498	H200
1011497	H210
1011496	H232
1011493	H302

Sisältää tallat



Jalka Heavy

1011482	H16	D50
1011481	H16	D60
1011480	H19	D80



Alatason kannatin

502004	H3	D40
502005	H3	D50
502006	H3	D60
502007	H3	D80



Alatason kannatin, suorapäinen

502022	H3	D40
502023	H3	D50
502024	H3	D60
502025	H3	D80

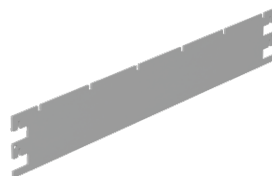

Välikannatin

1011504	D50
1011503	D60
1011502	D80

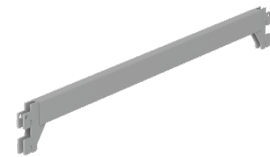

Vaakaputki

2004007	D50
2004008	D60
2004009	D80



Yliätuki

2003994	L60
2003993	L90
2003992	L120
2004094	L180

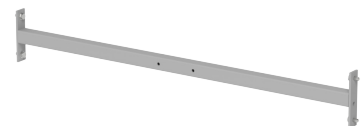

Välituki ruuvikiinnityksellä

1015068	L60
1014910	L90
1015069	L120

Heavy



Heavyn etuputkea voidaan käyttää myös perusjärjestelmän korkean ja matalan jalan kanssa. Tällöin alatasen kannattimen tilalla käytetään alatukea.

L=Leveys/cm

D=Syvyys/cm

H=Korkeus/cm

Ø mm

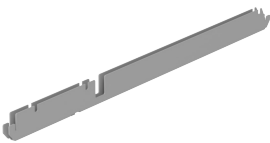

Alatuki

1016093	D40
1014572	D50
1014571	D60
1014570	D80

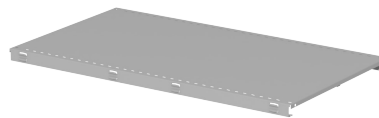

Teräshylly, käännettävä

501152	L60	D40	H3
501153	L60	D50	H3
501154	L60	D60	H3
501158	L90	D40	H3
501159	L90	D50	H3
501160	L90	D60	H3
501164	L120	D40	H3
501165	L120	D50	H3
501166	L120	D60	H3

Gondola



Gondola

L=Leveys/cm

D=Syvyys/cm

H=Korkeus/cm

Ø mm

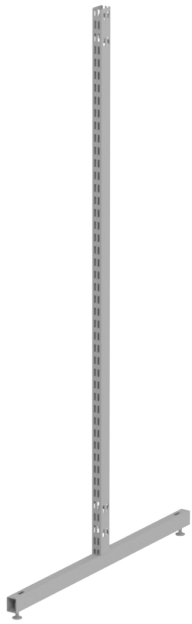

T-jalka

520412 L80 H146

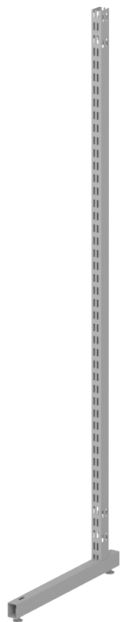

L-jalka Gondolaan

2000723 L40 H146



Huojuntatuki

520409 L60
520410 L90
520411 L120

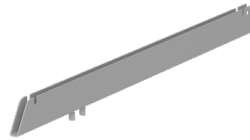

Alatason kannatin

502004 D40

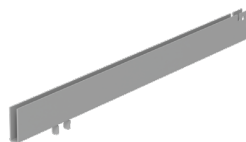

Alatason kannatin, suorapäinen

502022 D40



Pyörä

1005412 Ø 75 H100 mm



Pyörä jarrulla

1005413 Ø 75 H100 mm

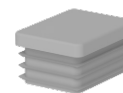

Sisätulppa muovi

800381 L3 D4 valkoinen
905830 L3 D4 harmaa
1003978 L3 D4 musta

L=Leveys/cm

D=Syvyys/cm

H=Korkeus/cm

Ø mm

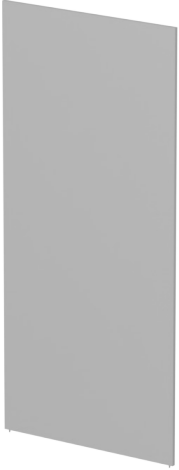
**Välitausta**

1005546	L60	H125
1005548	L90	H125
1005549	L120	H125

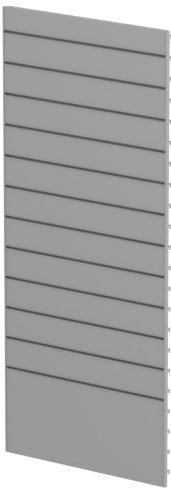
**Paneelitausta**

1005536	L60
1005541	L90
1005542	L120

**Peitekouru terästaustoille**

1005538	L60
1005543	L90
1005545	L120

**Peitekouru puutaustoille**

520389	L60
520390	L90
520391	L120

**Paneelipäätty kapea**

1005551	L30	H146
---------	-----	------

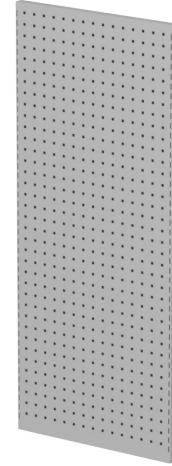
**Reikäpäätty**

1005558	L60	H146
---------	-----	------

**Sileäpäätty**

1005560	L30	H146
---------	-----	------

L=Leveys/cm

D=Syvyys/cm

H=Korkeus/cm

Ø mm

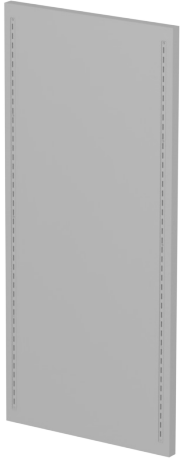

Puupääty säätölistoilla

1005529 L66 H146



Peilipääty

1003145 L44 H140

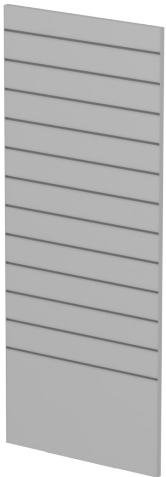

Paneelipääty

1005530 L60 H146

Varusteluosat

Teräshyllyt

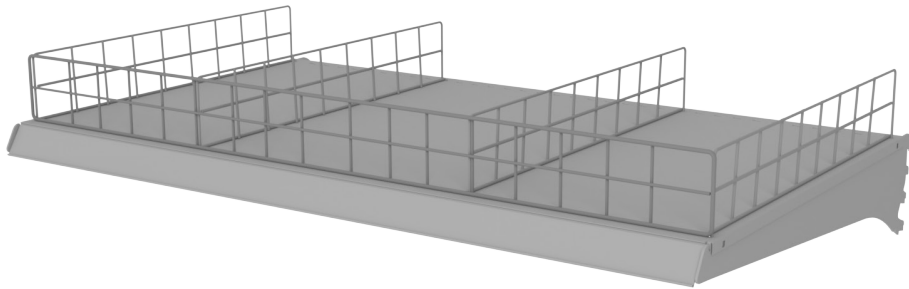

L=Leveys/cm

D=Syvyys/cm

H=Korkeus/cm

Ø mm

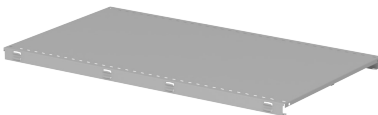

Teräshylly, käännettävä

501150	L60	D20	H3
501151	L60	D30	H3
501152	L60	D40	H3
501153	L60	D50	H3
501154	L60	D60	H3
501156	L90	D20	H3
501157	L90	D30	H3
501158	L90	D40	H3
501159	L90	D50	H3
501160	L90	D60	H3
501162	L120	D20	H3
501163	L120	D30	H3
501164	L120	D40	H3
501165	L120	D50	H3
501166	L120	D60	H3

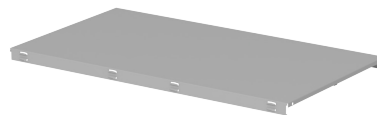

Teräshylly, käännettävä ilman reikiä

521152	L60	D40	H3
521153	L90	D40	H3



Ovaalireikähylly

1017094	L60	D40
1017093	L60	D50
1017092	L60	D60
1017091	L90	D40
1017090	L90	D50
1017089	L90	D60
1019646	L120	D40
1017762	L120	D50
1104871	L120	D60

Lankahylly

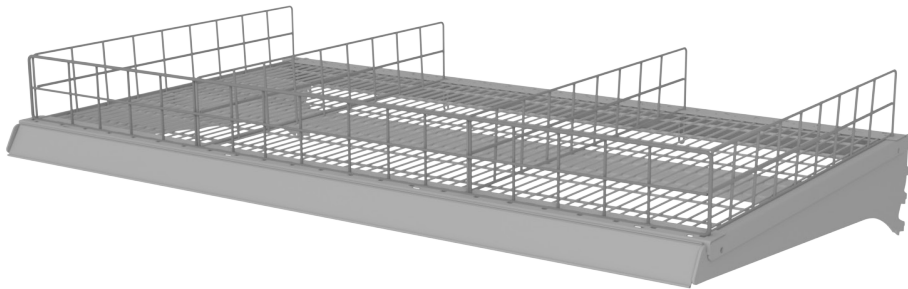

L=Leveys/cm

D=Syvyys/cm

H=Korkeus/cm

Ø mm



Lankahylly, sinkitty

1107814	L60	D40
1107815	L60	D50
1107816	L60	D60
1107817	L90	D40
1107818	L90	D50
1107819	L90	D60
1107820	L120	D40
1107821	L120	D50
1107822	L120	D50

Kannattimet

L=Leveys/cm

D=Syvyys/cm

H=Korkeus/cm

Ø mm



Hyllynkannatin, 4-asentoinen

501143	D40
501144	D50
501145	D60

Hyllynkulmat
+1°, -13°, -20°, -30°



Hyllynkannatin suorapäinen, 4-asentoinen

501482	D40
501483	D50
501484	D60

Hyllynkulmat
+1°, -13°, -20°, -30°



Hyllynkannatin, vahvistettu, 1-asentoinen

501147	D50
501148	D60
501149	D80

Ei kulmansäätöä



Hyllynkannatin 2-asentoinen

1004452	D20
1004442	D30
1004443	D40

Hyllynkulmat
+1°, -13°



Hyllynkannatin suorapäinen, 2-asentoinen

1004451	D20
1004441	D30
521154	D40

Hyllynkulmat
+1°, -13°



Teräshyllyn pidike

1103273	D1.5
---------	------

Teräshyllyn kiinnittämiseen alavinoon asentoon 2kpl/hylly.



Alavinokannatin 45°

501536	D30
520015	D50
520083	D60



Kaarikannatin teräshyllylle

520016	D20	H23
520017	D30	H23
520018	D40	H23
520019	D50	H23
520020	D60	H23

Reunat ja jakajat

L=Leveys/cm

D=Syvyys/cm

H=Korkeus/cm

Ø mm

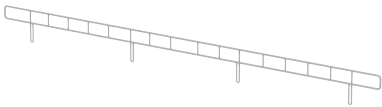

Ritiläreuna matala, sinkitty

520113	L60	H3
520114	L90	H3
520115	L120	H3

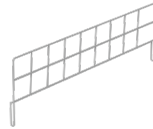

Ritiläjakaja, sinkitty

501254	D20	H8
501255	D30	H8
501256	D40	H8
501257	D50	H8
501258	D60	H8



Lasireuna ja kulma-pidikkeet teräshyllyyn

501424	L60	H5
501409	L60	H10
501434	L90	H5
501410	L90	H10
501435	L120	H5
501211	L120	H10

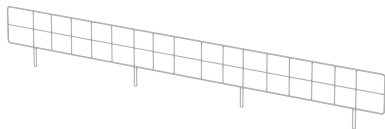

Ritiläreuna, sinkitty

501230	L60	H8
501231	L90	H8
501232	L120	H8

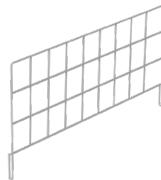

Ritiläjakaja korkea, sinkitty

520082	D30	H15
501261	D40	H15
501262	D50	H15
501263	D60	H15



Lasijakaja ja pidikkeet teräshyllyyn

501427	D20	H5	D1
501225	D20	H10	D1
501418	D30	H5	D1
501226	D30	H10	D1
501420	D40	H5	D1
501227	D40	H10	D1
501422	D50	H5	D1
501228	D50	H10	D1
501423	D60	H5	D1
501229	D60	H10	D1

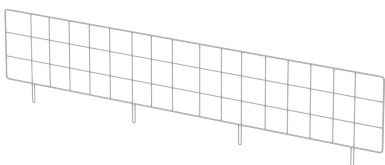

Ritiläreuna korkea, sinkitty

501250	L60	H15
501251	L90	H15
501252	L120	H15

L=Leveys/cm

D=Syvyys/cm

H=Korkeus/cm

Ø mm



**Lasijakajan kulmapidike
teräshyllyyn, muovi**

501415	H5
501209	H8
501208	H10



**Lasijakajan pidike
teräshyllyyn, muovi**

501248	H5
501249	H8
501207	H10

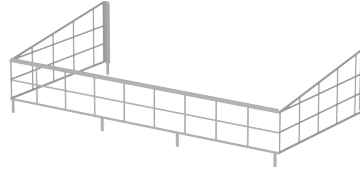

Laarikaulus hyllylle

1108370	L60	D40	H19
1104929	L90	D40	H19
1025153	L90	D50	H19
1107701	L90	D60	H19
1105618	L120	D30	H19
1105619	L120	D40	H19
1025295	L120	D50	H19

Puuhyilly



L=Leveys/cm

D=Syvyys/cm

H=Korkeus/cm

Ø mm

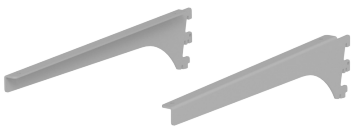

Puuhyllyn kannatinpari, 2-asentoinen, (sis. kiinnityssarjan)

521008	D20
521009	D30
521010	D40



Puuhyilly kannattimiin valkoinen

1110486	L60	D20
1110487	L60	D30
1110488	L60	D40
1110489	L90	D20
1110490	L90	D30
1110491	L90	D40



Puuhyilly kannattimiin musta

1110495	L60	D20
1110496	L60	D30
1110497	L60	D40
1110492	L90	D20
1110493	L90	D30
1110494	L90	D40

Puuhyly kannatinlistoilla



L=Leveys/cm

D=Syvyys/cm

H=Korkeus/cm

Ø mm



Puuhylyn kannatinlista + ruuvit

550272	D30
550273	D40
550274	D50
550271	D60



Puuhyly kannatinlistoihin valkoinen

1014390	L60	D30
1025215	L60	D40
1110478	L60	D50
1110479	L60	D60
1110477	L90	D30
1006921	L90	D40
1009133	L90	D50
1006920	L90	D60



Puuhyly kannatinlistoihin musta

1110482	L60	D30
1110483	L60	D40
1110484	L60	D50
1110485	L60	D60
1110480	L90	D30
1110481	L90	D40
1108420	L90	D50
1107580	L90	D60

Lasihylly



L=Leveys/cm

D=Syvyys/cm

H=Korkeus/cm

Ø mm

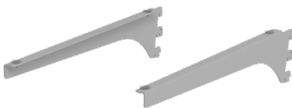

Lasihyllyn kannatinpari, 2-asentoinen, (sis. imukupit)

521008-L	D20
521009-L	D30
521010-L	D40



Lasihylly kannattimiin kirkas 8 mm karkaisematon

521091	L60	D20
521092	L60	D30
521093	L60	D40
521094	L90	D20
521095	L90	D30
521096	L90	D40
521097	L120	D20
521098	L120	D30
521099	L120	D40

Lasihylly kehyksellä

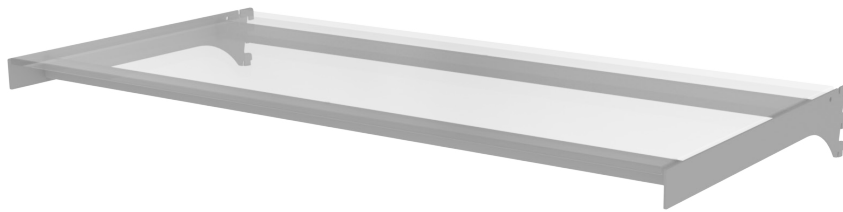

L=Leveys/cm

D=Syvyyys/cm

H=Korkeus/cm

Ø mm



Lasihyllyn kehys

550072	L60	D30
550073	L60	D40
550154	L90	D30
550155	L90	D40
550152	L120	D30
550153	L120	D40



Lasihylly kehykseen kirkas 8 mm karkaisematon

501697	L60	D30
501698	L60	D40
501634	L90	D30
501635	L90	D40
501651	L120	D30
501652	L120	D40

Muut hyllyt

L=Leveys/cm

D=Syvyys/cm

H=Korkeus/cm

Ø mm

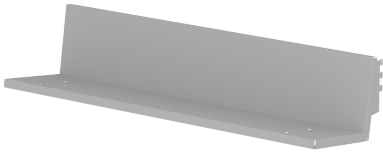

Kirjahylly

520116	L60	D16	H18
520117	L90	D16	H18
520118	L120	D16	H18
1005561	L60	D23	H18
1005564	L90	D23	H18
1005611	L120	D23	H18
1005613	L60	D30	H18
1005614	L90	D30	H18
1005615	L120	D30	H18

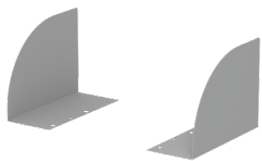

Kirjatukipari hyllyyn

521019	L9	D16	H17
1005616	L9	D23	H17
1005617	L9	D30	H17

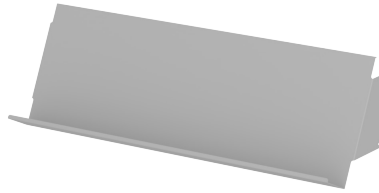

Lehtihylly

1010843	L60	D8	H30
1010832	L90	D8	H30
1010429	L120	D8	H30

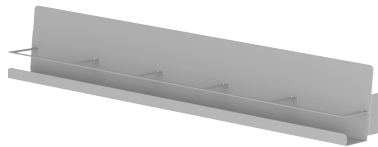

CD/DVD-hylly

521214	L90
--------	-----

Muut hyllyt

L=Leveys/cm

D=Syvyys/cm

H=Korkeus/cm

Ø mm

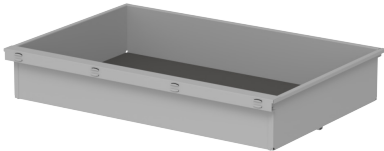

Alakaukalo kumimatolla

1018024	L90	D50	H15
501330	L90	D60	H15
501340	L120	D60	H15

+ muut mitat

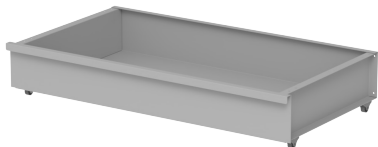

Sokkelilaatikko pyörillä

1003694	L90	D40	H16
1005877	L90	D50	H16
2008833	L90	D60	H16

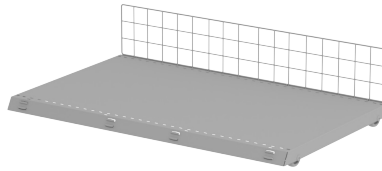

Alataso pyörillä vinoreuna+ritiläreuna korkea

2024195	L60	D40	H15
2024196	L60	D50	H15
2024197	L60	D60	H15

2024198	L90	D40	H15
2024199	L90	D50	H15
2024200	L90	D60	H15

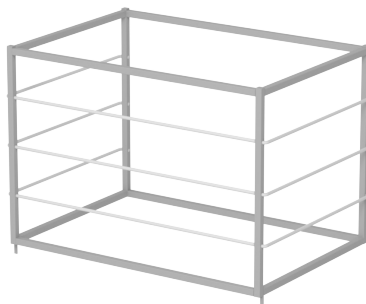

Pallokori teräshyllyyn

1003748	L90	D50	H60
---------	-----	-----	-----

Laarikorit



L=Leveys/cm

D=Syvyys/cm

H=Korkeus/cm

Ø mm

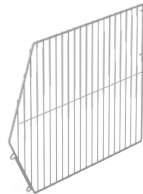
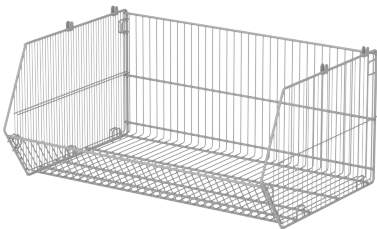

Laarikori, sinkitty

520036	L90	D40	H40
501889	L90	D50	H40
501890	L90	D60	H40

520040	L120	D40	H40
501812	L120	D50	H40
501813	L120	D60	H40

Laarikorin jakaja, sinkitty

520042	D40	H40
501861	D50	H40
501862	D60	H40

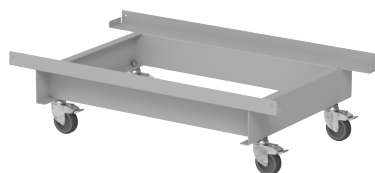

Korivaunu, sinkitty

501865	L90	D60
501830	L120	D60

Laarikorin kiinnitin teräshyllyyn, sinkitty, 2 kpl/kori

581122	H6
--------	----



Hintalistan kannatin laarikoriin

520240-51

Hintalistat

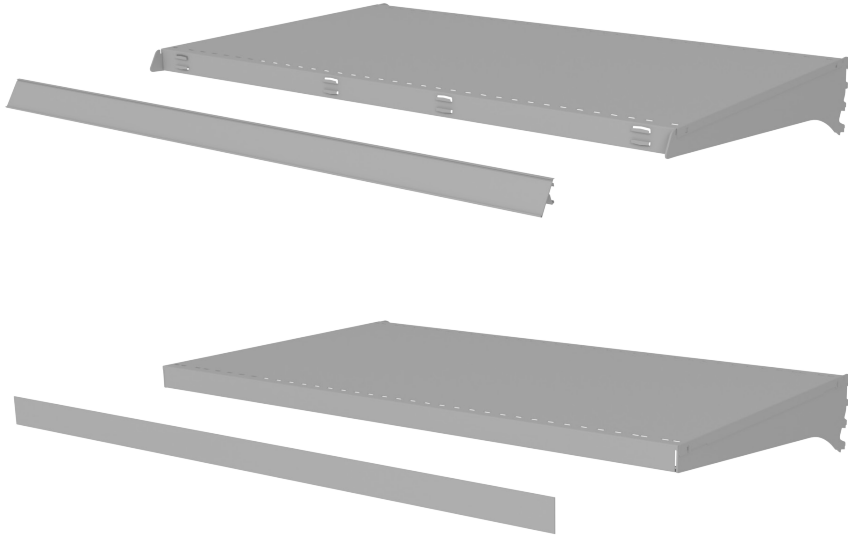

L=Leveys/cm

D=Syvyys/cm

H=Korkeus/cm

Ø mm

Hintalista 39, muovi

Kirkas

1103066	L60	H4	39
1018896	L90	H4	39
1104557	L120	H4	39

Valkoinen

501195	L60	H4	39
501196	L90	H4	39
501197	L120	H4	39

Harmaa RAL 7045

1107192	L60	H4	39
520206	L90	H4	39
1109095	L120	H4	39

Hintalista 52, muovi

Kirkas

1004600	L60	H5	52
520215	L90	H5	52
520216	L120	H5	52

Valkoinen

1017043	L60	H5	52
1017042	L90	H5	52
1020200	L120	H5	52

Harmaa RAL 7045

520209	L90	H5	52
520210	L120	H5	52

Musta

1107637	L60	H5	52
1105323	L90	H5	52
1105912	L120	H5	52

Hintalista, liimattava, muovi

Kirkas

1013015	L60	H3	26
501985	L90	H3	26
520137	L120	H3	26

Kirkas

1019765	L60	H4	39
501986	L90	H4	39
520138	L120	H4	39

Kirkas

584042	L90	H5	52
584043	L120	H5	52

Musta

1108166	L90	H5	52
---------	-----	----	----

Hintalistan kannatin



Hintalistan kannattimia tarvitaan 2 kpl / hintalista.
 Hintalistan kannatin taivutetaan määrämittaansa asennettaessa.

L=Leveys/cm

D=Syvyys/cm

H=Korkeus/cm

Ø mm

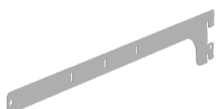

Hintalistan kannatin

1101295 10 / 15 / 20 cm

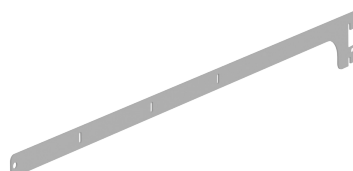

Hintalistan kannatin

1101296 20 / 30 / 40 cm



Hintalistan kiinnitysprofili

587000	L60	H2
587001	L90	H2
587002	L120	H2

Hintalistat

L=Leveys/cm

D=Syvyys/cm

H=Korkeus/cm

Ø mm



Hintalista T-pidikkeeseen, kirkas muovi

520220	L5.5	H3	26
550087	L5.5	H4	39
1010769	L6	H4	39
1103479	L7.5	H4	39
550088	L10.5	H4	39
550184	L5.2	H5.2	52
1023916	L9.5	H5.2	52
550185	L10.5	H5.2	52
550180	L10.5	H6	60

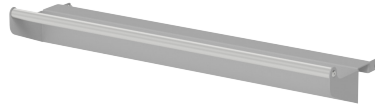

Hinnannäytön törmäyssuoja rst-putkella

1102535	L60
1102321	L90
1102536	L120

Sopii matalaan ja korkeaan
jalkaosaan

Infoprofiili

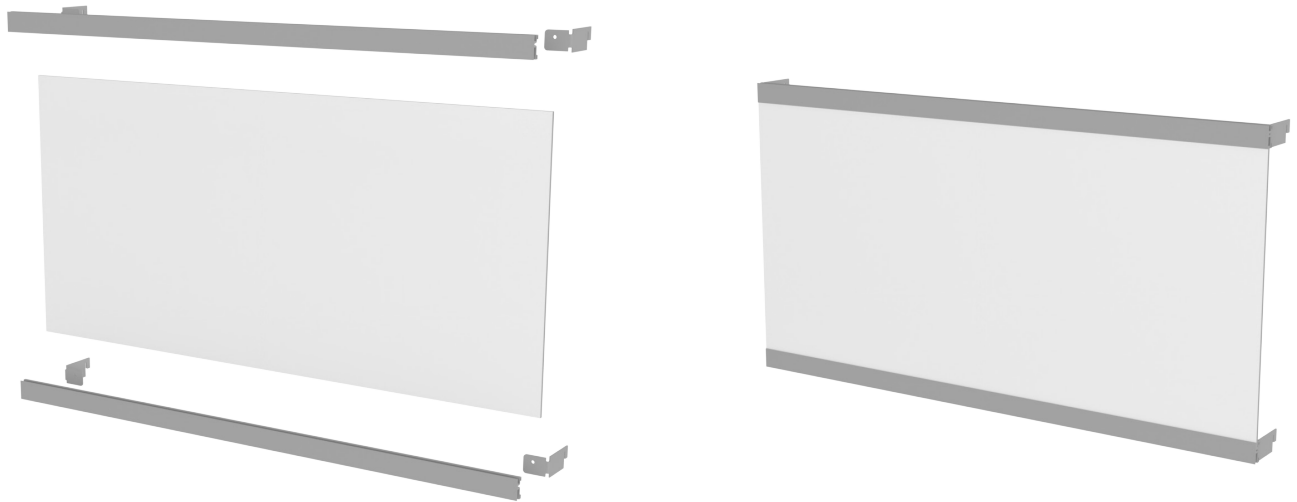

Infoprofiilin korkeus on 32 mm.
 Infolevyn max. paksuus 6 mm.
 Infolevyn korkeus, kun kannattimet on asennettu säätöputkiin on: (x*32)-20 mm

L=Leveys/cm D=Syvyys/cm H=Korkeus/cm Ø mm



Infoprofiilin kannatinpari

550325 D5



Infoprofiili

801829 L60
 801830 L90
 801831 L12

Tuoteinfot

L=Leveys/cm

D=Syvyys/cm

H=Korkeus/cm

Ø mm

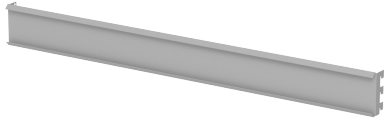

Infolista

1016513	L60	H9
521216	L90	H9
1012976	L120	H9

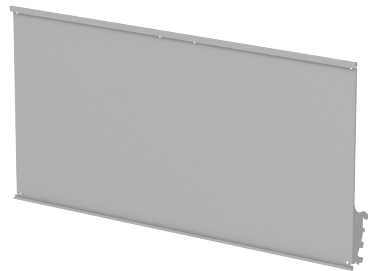

Infokehys säädettävä

2008430	L60	H45
2006147	L90	H45
2009547	L120	H45

Asennot suora, sekä 13 ja 30 astetta kallistettu

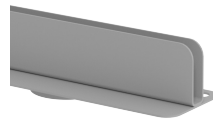

Infokouru magneetilla

1005411	L60	D3	H2
1005415	L90	D3	H2

Kouruun sopii 5 mm paksu infolevy



Tuoteinfo A4 kierteeseen M10

521303	H8
--------	----



Tuoteinfo A4 magneetilla

1005426	H8
---------	----



Tuoteinfo A4 jalalla

521304	H25
--------	-----

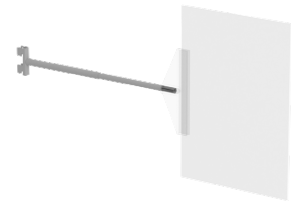

Tuoteinfo A4 säätöputkeen

621305	D35-65
--------	--------

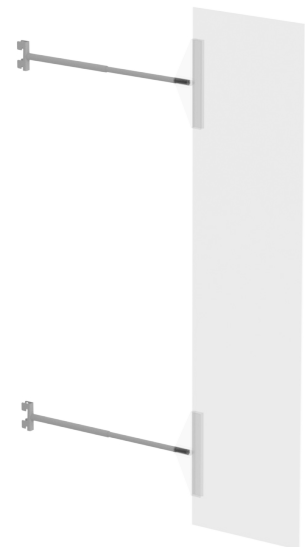

Tuoteinfo 3x4 säätöputkeen

1005544	D35-65
---------	--------

Rekki

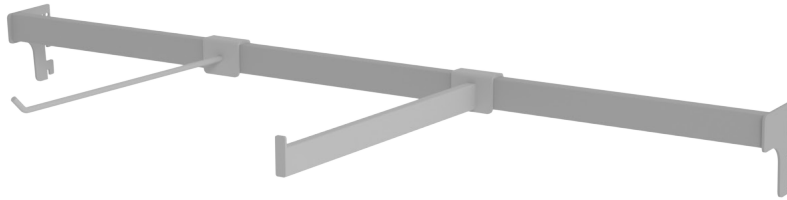

L=Leveys/cm

D=Syvyys/cm

H=Korkeus/cm

Ø mm



Rekki korvakkeilla, kromattu

501170	L60	D5
501171	L90	D5
501172	L120	D5



Rekki kannattimilla

1017726	L60	D25
1017725	L90	D25
1017724	L120	D25
1012363	L60	D30
1012362	L90	D30
1012361	L120	D30
1017723	L60	D35
1017722	L90	D35
1017721	L120	D35



Pientavarakannatin rekkiin, kromattu

500274	D10	Ø4
500283	D15	Ø4
500282	D20	Ø6
500284	D25	Ø6
520077	D30	Ø6
583021	D30	Ø8
520397	D40	Ø8

L=Leveys/cm

D=Syvyys/cm

H=Korkeus/cm

Ø mm

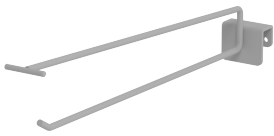

Lankakannatin rekkiin, T-pidike, kromattu

550108	D15	Ø5
550109	D25	Ø5
550110	D30	Ø6
550111	D40	Ø8



Kaksoislankakannatin rekkiin, kromattu

500294	D10	Ø4
500295	D15	Ø4
500289	D20	Ø5
500296	D25	Ø5



Kaksoislankakannatin rekkiin, T-pidike, kromattu

550112	D15	Ø5
550113	D25	Ø5
550114	D30	Ø6



Lattakannatin rekkiin, kromattu

520363	D30
520029	D40



Kannatin rekkiin laipalla, kromattu

500290	D30x8
500291	D40x8

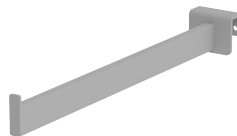

Suora esittelykannatin, kromattu

520366	D30
520367	D40
520368	D50

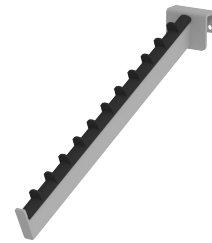

Alavino esittelykannatin, kromattu

520369	D30
520370	D40

Muovinen peitelista, musta

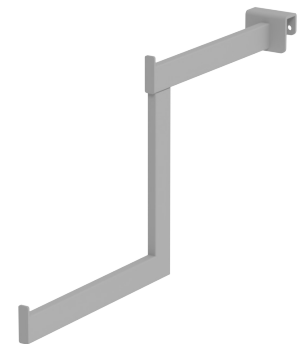

Porrastettu esittelykannatin, kromattu

520371	D40
--------	-----



Sivuesittelyreikki, kromattu

520080	L60	D30
--------	-----	-----

Lattarekki

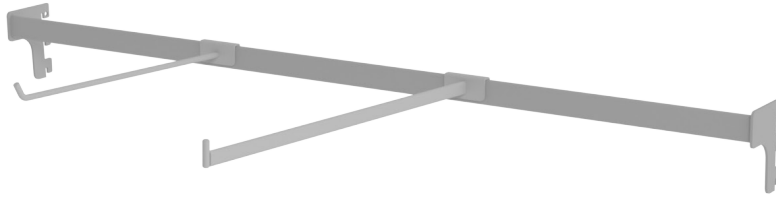

L=Leveys/cm

D=Syvyys/cm

H=Korkeus/cm

Ø mm



Lattarekki, kromattu

501338	L60	D5
501322	L90	D5
501336	L120	D5



Lattarekki, kromattu

501339	L60	D12
501335	L90	D12
501337	L120	D12



Pientavarakannatin lattarekkiin, kromattu

502071	D5	Ø4
502072	D10	Ø4
502073	D15	Ø4
520027	D30	Ø6
520028	D35	Ø8

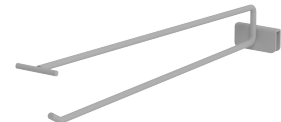

Pientavarakannatin lattarekkiin, T-pidike, kromattu

1005149	D15	Ø6
1009963	D20	Ø6
1005148	D25	Ø5
1004597	D30	Ø6



Kannatin lattarekkiin, kromattu

502074	D40
--------	-----

Raskaan tavaran rekki

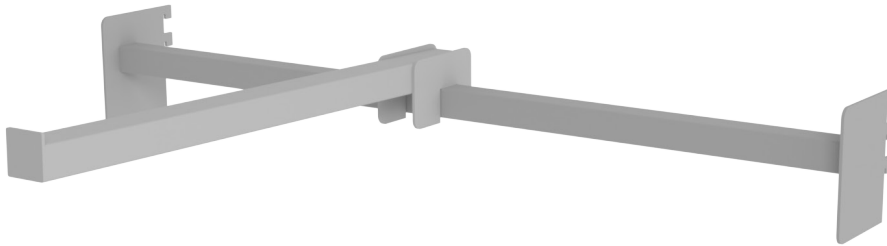

L=Leveys/cm

D=Syvyys/cm

H=Korkeus/cm

Ø mm



**Rekki raskaan tavaran
kannattimelle, maalattu**

520012 L60
520010 L90
520011 L120



**Raskaan tavaran kannatin,
maalattu**

520013 D60

Säätörekki



L=Leveys/cm

D=Syvyys/cm

H=Korkeus/cm

Ø mm



Säätörekki, kromattu

521014	L60	D5
521015	L90	D5
521016	L120	D5



Pystyjakaja säätörekkiin, kromattu

520136	D38	H70	Ø8
--------	-----	-----	----

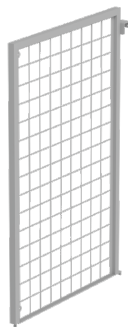

Massajakaja säätörekkiin

520170	D60	H84
520171	D80	H84



Massajakajan päätputki

501905	D7	H76
--------	----	-----



Valmisverhokannatin

1003460	D55
---------	-----

L=Leveys/cm

D=Syvyys/cm

H=Korkeus/cm

Ø mm

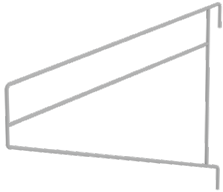
**Vuodevaatekannatin
säätörekkiin, kromattu**

521011 D80

**Kääntyvä vapateline**

2008828 D60 H100

Paneelin varusteluosat

L=Leveys/cm

D=Syvyys/cm

H=Korkeus/cm

Ø mm



Pientavarakannatin paneeliin, kromattu

500302	D10	Ø4
500303	D15	Ø4
500308	D20	Ø6
500304	D25	Ø6
520081	D30	Ø6

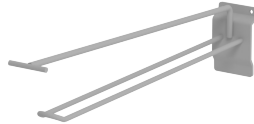

Kaksoislankakannatin paneeliin, T-pidike, kromattu

550104	D15	Ø5
1010437	D20	Ø5
550106	D30	Ø6
550107	D40	Ø8



Kannatin paneeliin, kromattu

520076	D30	Ø8
500319	D40	Ø8



Lankakannatin paneeliin, T-pidike, kromattu

550100	D15	Ø5
550102	D30	Ø6
550103	D40	Ø8



Suora esittelykannatin paneeliin, kromattu

520372	D10
521052	D20
520373	D30
520374	D40

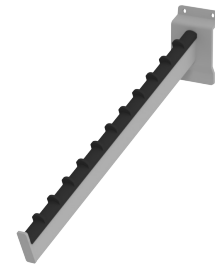

Alavino esittelykannatin paneeliin, kromattu

521053	D30
520375	D40



Kaksoislankakannatin paneeliin, kromattu

500320	D10	Ø4
500321	D15	Ø4
500356	D20	Ø6
500322	D25	Ø6



Suora esittelykannatin

521001	D10
521002	D30

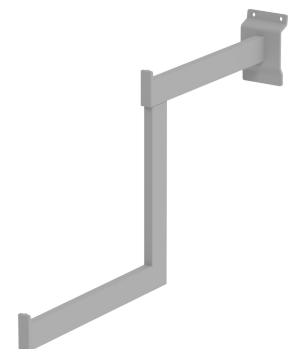

Porrastettu esittelykannatin paneeliin, kromattu

521054	D40
--------	-----

L=Leveys/cm

D=Syvyys/cm

H=Korkeus/cm

Ø mm

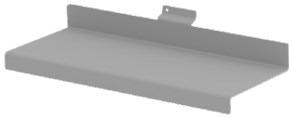

Suora esittelytaso

521024 L30 D13

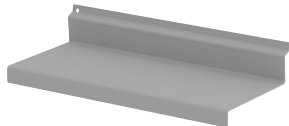

Suora esittelytaso paneeliin

521022 L30 D13



Esillepanohylly paneeliin

1016448 L60 D20



Vino esittelytaso

521021 L22 D31

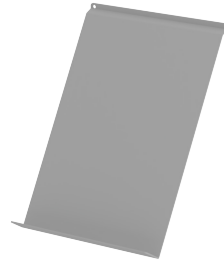

Vino esittelytaso paneeliin

500275 L15 H21
521020 L22 H31



Puu/lasihyllyn kannatin paneeliin

521044 D20
521046 D30
521048 D40



Pallokannatin paneeliin

521017 D30

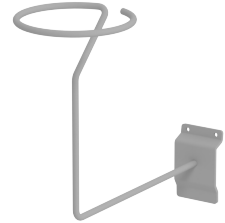

Hattukannatin paneeliin, kromattu

500340 D20 H19

Reikätaustan varusteluosat

L=Leveys/cm

D=Syvyys/cm

H=Korkeus/cm

Ø mm



Pientavarakannatin R-taustaan, sinkitty

501867	D5	Ø4
501869	D10	Ø4
501870	D15	Ø4
501871	D20	Ø4
501872	D15	Ø6
501873	D20	Ø6



Pientavarakannatin R-taustaan, sinkitty

501874	D30	Ø6
501875	D30	Ø8
520078	D40	Ø8
520079	D50	Ø8



Kaksoislankakannati R-taustaan, sinkitty

520066	D20	Ø5
520067	D30	Ø5



Kaksoislankakannati R-taustaan, sinkitty

501879	D10	Ø4
501880	D20	Ø4
501881	D30	Ø4

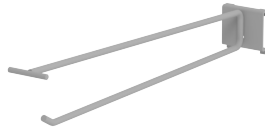

Lankakannatin R-taustaan T-pidike, sinkitty

520200	D20	Ø5
520201	D30	Ø6
520202	D30	Ø8
1008436	D40	Ø8



U-koukkukannake R-taustaan, sinkitty

501886	D8
--------	----



Hyllytaso R-taustaan, maalattu

1005453	L35	D12	H1
---------	-----	-----	----



Hylly R-taustaan, maalattu

2005517	L37	D14	H3
2005216	L47	D14	H3



Hyllyreunus

2006240	L47	D14	H3
---------	-----	-----	----

L=Leveys/cm

D=Syvyys/cm

H=Korkeus/cm

Ø mm

**Korttilokero R-taustaan**

2002845 L12 D3 H11

**Pidätinruuvi R-kannattimelle**

906670 M5x10(100 kpl)

Tilattava erikseen

Varusteluosat säätöputkeen

L=Leveys/cm

D=Syvyys/cm

H=Korkeus/cm

Ø mm



Kannatin säätöreikiin, kromattu

1004878	D25	Ø8
520392	D30	Ø8



Esittelykannatin säätöreikiin, kromattu

1004883	D25
520393	D30
520394	D40



Clipstrip kannatin

550352	H90
--------	-----

Värit ja materiaalit

Kattavasta väri- ja materiaalivalikoimastamme voit valita myymäläsi ilmeeseen parhaiten sopivat vaihtoehdot.

Seuraavilla sivuilla on esimerkkejä varastoitavista väreistämme sekä melamiini- ja laminaattipinnoista. Saatavilla on myös muita sävyjä.

Vakiovärit

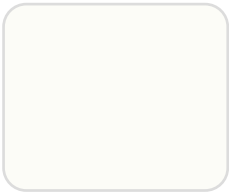

RAL 9010

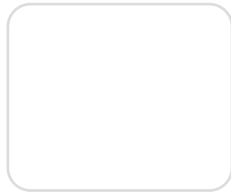

RAL 9016

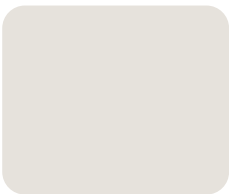

RAL 7047



RAL 7040



RAL 7045



RAL 7015



DA 4153

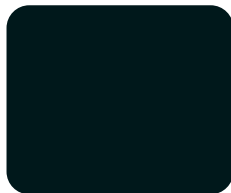

RAL 9005



RAL 9005
Strukturi

Huomioithan, että näytöllä värit voivat poiketa todellisesta. Varmista väri tarvittaessa mallipalasta.

Melamiinit ja laminaatit

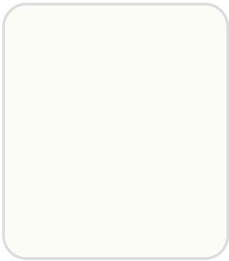

Valkoinen



Musta



Mel 5762

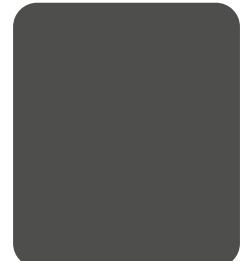

Mel 508



Saarni



Vicenza Oak



Madura Oak



Elegant Oak
F5374 NAT

Huomioithan, että näytöllä värit voivat poiketa todellisesta.
Varmista väri tarvittaessa mallipalasta.

ITAB

RETHINK RETAIL. TOGETHER.

ITAB Finland Oy
Robert Huberin tie 3B
01510 Vantaa
Finland

Haapaniementie 3
40800 Vaajakoski
Finland

Puh: 0207 121 611
asiakaspalvelu@itab.com
www.itab.fi

